

The AGA Compact



The AGA Compact is built around the essentials of AGA cooking, centred on cast-iron, heat-storage ovens and the steady heat they provide. With an induction hob for added speed and control when needed, it holds to the principles that define a heat-storage AGA cooker while offering greater flexibility for how you cook day to day.

Smaller in depth than the Classic and Signature models, the AGA Compact is designed to sit neatly within standard kitchen cabinetry.

KEY FEATURES

- Available in 90cm, 100cm and 110cm widths
- boiling / simmering plate with two- or three-zone induction hob depending on model size
- Two cast-iron ovens for roasting/ baking and simmering, with a stainless-steel warming oven and cookware storage (depending on width)
- Cast-iron resting area
- Fully electric and compatible with solar and renewable energy
- AGA-branded stainless-steel handrail
- Choice of enamelled or stainless-steel hotplate lids
- Create a more personal configuration with an optional 60cm AGA Extension Module, allowing your cooker to be extended to 150cm, 160cm or 170cm
- Room vented

COLOUR OPTIONS



18 VITREOUS
 ENAMEL COLOURS

*A bespoke colour service
 is also available*

SPECIFICATIONS

	90cm	100cm	110cm	60cm Extension Module
HEIGHT (MM)	913	913	913	913
WIDTH (MM)	900	984	1100	616
DEPTH (MM)*	634	634	634	634
WARRANTY (YEARS)	5	5	5	5

*Depth excludes handrail.

LAYOUT / CONFIGURATION

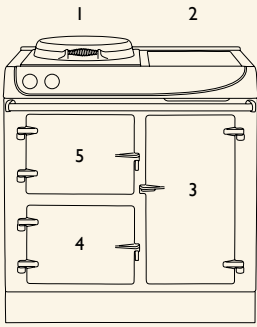

AGA Compact 90cm

Key	Function
1	Boiling / simmering plate
2	Two-zone induction hob
3	Stainless-steel warming oven
4	Cast-iron simmering oven
5	Cast-iron roasting / baking oven

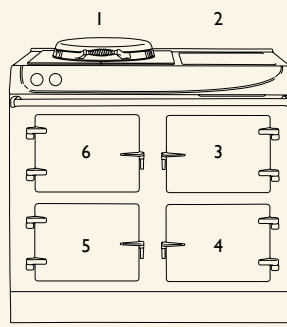

AGA Compact 100cm

Key	Function
1	Boiling / simmering plate
2	Two-zone induction hob
3	Cookware storage
4	Stainless-steel warming oven
5	Cast-iron simmering oven
6	Cast-iron roasting / baking oven

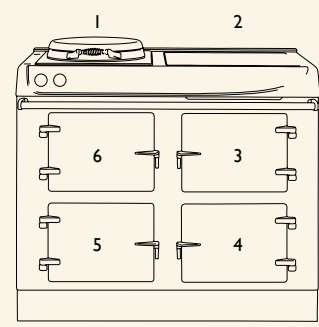

AGA Compact 110cm

Key	Function
1	Boiling / simmering plate
2	Three-zone induction hob
3	Cookware storage
4	Stainless-steel warming oven
5	Cast-iron simmering oven
6	Cast-iron roasting / baking oven

Extension Module options

60cm AGA Extension Module

The AGA Compact 60cm Extension Module pairs a tall conventional fan oven with a simmering plate, bringing added capacity and versatility to the kitchen, as well as greater flexibility in the way you cook.

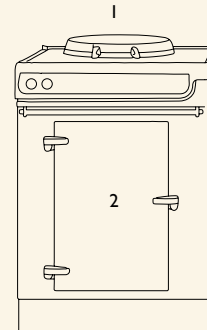

Key	Function
1	Simmering plate
2	A-rated fan oven

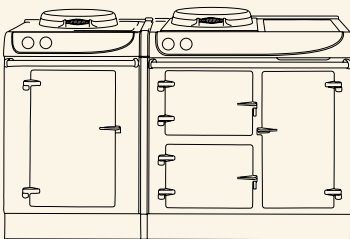

AGA Compact 150

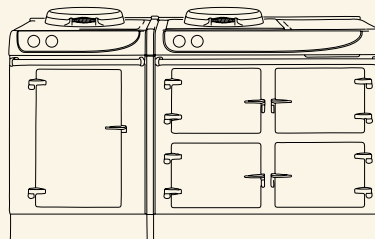

AGA Compact 160

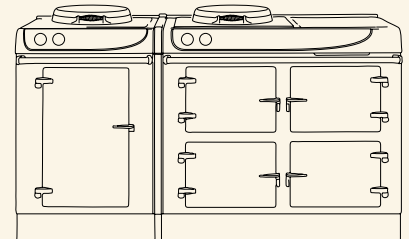

AGA Compact 170

AGA®